

To Know More About Us  
Scan QR Code



 Dr. Odin<sup>®</sup>

## Portable Phlegm Suction Unit

H003B

### Operational Manual



**DO NOT OPERATE THIS PRODUCT WITHOUT FIRST  
READING AND UNDERSTANDING THIS MANUAL**

## INDEX

I .Safety notes.....	1
II .Product features.....	1-2
III .Installing and commissioning.....	3-5
IV .Application and maintenance.....	5-7
V .Trouble shooting.....	7-8
VI .Other precautions.....	8
VII .Form for electromagnetism compatibility.....	9-11
VIII .After-sale service.....	12

## I 、 Safety notes

### 1. Warning:

Do not disassemble or attempt to repair the product. All repairs should be done by qualified personnel at an authorized repair center.

### 2. Important safeguards:

When using electrical products, especially when children are present, basic safety precaution should always be followed including the following:

1) DANGER-To reduce the risk of electrocution:

1. Always unplug this product immediately after using.
2. Do not use while bathing.
3. Do not reach for product that has fallen into water. UNPLUG IMMEDIATELY.
4. Do not place or store product where it can into water or other liquid.
5. Do not come in contact with the suction apparatus while wet.
6. Do not disassemble. Refer servicing to qualified service personnel.

2) WARNING-To reduce the risk of burns, electrocution, fire or injury to persons:

1. A product should never be left unattended when plugged in.
2. Close supervision is necessary when this product is used near children or physically-challenged individuals.
3. Do not use spare parts or accessories without manufacturer approval or it will reduce performance of the machine.
4. If it fall into water, don't touch, cut off the power supply immediately ,and contact with qualified distribution or manufacturer.
5. Keep the power supply away from heated or hot surfaces.
6. Product shall not be placed in the airflow obstruction in the environment.
7. Do not use the product when sleeping or drowsy.
8. Never drop or insert any object into any openings.

## II 、 PRODUCT FEATURES

### 1.General

The portable phlegm suction aspirator designed based on developing orientation of similar products at home and abroad is a new generation of oil free lubrication suction device ,which is suitable for use by the patient who has difficulty in phlegm removal due to illness ,coma and operation ,as well as for aspirating such liquid as pus and blood during the clinical practice.It is the commonly applied medical device for use in the emergency room ,operation room,and for nursing in sickroom care.

### 2. Characteristics and working principle

- Oil free lubrication pump applied to keep the environment from being polluted by the oil mist.

- Large flux and low noise design.
- Adopt completely plastic panel design which have good waterproof quantity.
- With overflow device to prevent liquid into the pump.
- It can adjust negative pressure according to your request.
- Suitable for first-aid and outdoor go-round for medical treatment because of its features such as small volume ,light weight ,and easy to carry about.

The working principle diagram below:

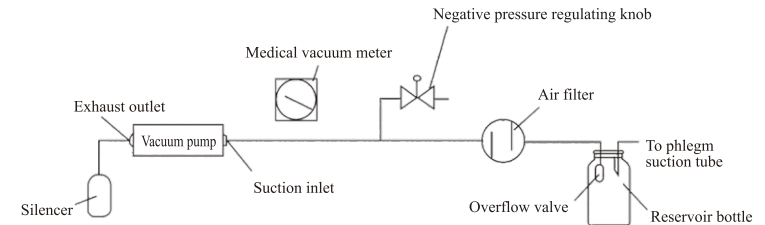

### 3.Main Technical Performances

- (1) Max negative pressure value:  $\geq 0.075$ MPa
- (2) Adjustable negative pressure range: 0.02MPa~Max negative pressure value
- (3) Pumping rate: 18L/min
- (4) Sound Level :  $\leq 60$ dB (A)
- (5) Suction bottle : 1000mL/bottle
- (6) Power supply : AC 220V 50Hz
- (7) Input power : 90VA
- (8) Fuse tube : F1.6AL 250V  $\Phi 5 \times 20$
- (9) Dimension: 335\*240\*150mm ;

- The aspirator is not suitable for use in the place with inflammable & explosive gas.
- Working system: short-time operation.
- Electric safety requirement : II a

### 4.Normal Operating Conditions

- Ambient temperature: 5~40℃;
- Relative humidity:  $\leq 80\%$ ;
- Atmospheric pressure: 86~106kPa.

When the storage temperature is below 5℃, before using the device should be placed in a normal working environment more than four hours.

### III、INSTALLING AND COMMISSIONING

#### 1. Open Package Inspection

The customer shall carefully inspect if the appearance of product is good ,and the variety & quantities of the attachments are in conformity with tube as indicated in the attached list before installing and commissioning .Also ,the customer shall timely notify the supplier or manufacturer of damage(s) if any.

#### 2. Connecting (See Tube Connecting Diagram ,with phlegm suction tube temporarily not connected)

1. Reservoir bottle
2. Suction soft pipe
3. Air filter
4. Float
5. Suction soft pipe (length 1.3m)

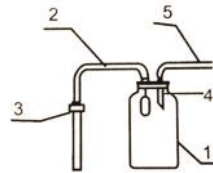

#### 3. Power line connection

Connect the plug with the power source .Turn on the power supply ,and then the suction device is running.

#### 4. Connector inspection

- Turn tightly the negative pressure regulating valve clockwise ,and block the air suction inlet with the finger or the rubber head of dropper ,or fold up and hold the suction tube.
- Start the suction device for running with no strange sound ,the pointer on the vacuum meter will quickly reach up to the limit negative pressure .Release the suction inlet ,the pointer will return below 0.02MPa.If so ,the connector can be regarded as being in good connection.
- Note:Dredge the suction tube if blocked as per the following method :Bend the suction conductor in “V”form (with no liquid in the holder) , and release it to the original status when the negative pressure reaches up to the maximum value .Repeat this procedure several times till the tube is not blocked.

#### 5. Negative pressure regulating

- Block the suction inlet ,open the portable phlegm suction unit switch and regulate the negative pressure valve ,and the readings on the medical vacuum gauge shall be within 0.02MPa~ Max negative pressure value.
- Control the negative pressure as required for suction by means of the negative pressure valve at the time of clinical practice.
- Increase the negative pressure by turning the valve clockwise.
- Reduce the negative pressure below 0.02MPa prior to power shut-off.

#### 6. Inspection & Test on the overflow device

- Open the holder plug ,clean up the valve mouth ,and leveling the rubber valve clack on the float.The valve clack shall not be warped ,bent and broken ,but well connected with the float .The float shall be able to move freely in its support without any blockage.
- Lift the holder plug with hand to make the float contact the water surface perpendicularly .Gradually lower the holder cover to let the float rise.

















- Tighten the hold plug ,attach the suction tube conductor at the inlet ,and screw firmly the regulating valve, then ,actuate the portable phlegm suction unit.
- Put the Suction soft tube into one clean water pail or attempt to simulate actual application to suction the liquid into the holder of the overflow device .As a result ,the float will rise as the liquid level ascends until the valve is closed and suction stops automatically .The final position of liquid level depends on the suction process adopted.
- Release the regulating valve ,set the portable phlegm suction unit switch off ,open the holder plug and empty the liquid in the holder .The float shall be at the bottom of the support and the valve is in open status in case of re-screwing firmly the hold plug.  
If so ,the overflow device is considered as being in normal condition ,which can be used for clinical practice.

#### Note:

- The liquid level still continuously ascends after the overflow device has been shut off ,possibly due to:
  - A. Residual negative pressure still in the holder.
  - B. Valve mouth not fully closed.For Item A,the liquid level in the holder will not ascend when the suction tube conductor is placed again into the liquid as suctioned ,and for Item B ,the liquid level still ascends .Thus ,it is required to observe carefully ,and lift immediately the conductor out of the suctioned liquid when the holder is close to full ,then ,switch off the aspirator to stop suction ,and examine the possible reason of the valve fault.
- The float is still adhered on the valve mouth as already closed by the float ,possibly due to the negative pressure in the line .At this moment ,release the regulating valve or shut off the aspirator (to release the negative pressure in the line ),the float will descends from the valve mouth under the action of gravity .(It is forbidden to pull the float with hand ,in order to avoid the rubber valve clack being separated from the float. Float on the mucus, if any, should be thoroughly clean the rear can be used again.)
- After shut-off ,release the negative pressure ,then ,open the holder plug.
- Never use the portable phlegm suction unit under the condition of the overflow device dismantled.



## 7. Symbol marked

Symbol	Meaning	Symbol	Meaning
	EU Notified Body number of CE certification bodies		Operating instructions
	Class II equipment		Type B applied part
	“ON”(power)		“OFF”(power)
	Manufacturer		Authorized representative in the European Community
	Serial number		Date of manufacture
	Batch code		This side up
	Fragile,handle with care		Keep dry
	Temperature limit		The product should be thrown away after use, payable to a dedicated recycling place.

The installation of sealing ring:

For the better sealing effect, our liquid bottle cap adopted the sealing ring with one smooth side,the other is groove. Please use the smooth side joint cap during installation.

## IV、 APPLICATION AND MAINTENANCE

### 1. Application and Maintenance

- Check the aspirator before using as per the installing and commissioning sequence to ensure its good performances ,afterwards ,start operation by connecting the suction conductor and the phlegm suction tube already sterilized.

**Attention:** cannula can buy separately according to the doctor's advice or need (suggest to use disposable one). Please using the good quality cannula and operate follow the instructions.

- Regulate the negative pressure as required for suction through the regulating valve ,open/close the switch based on the situation ,and observe frequently the liquid level in the holder in the process of operation .Stop suction if the liquid level in the holder ascends to the rated capacity(still applicable if slanting

aspirator 10°), and re-use it after empty and clean-up .Otherwise ,the float will rise as the liquid level ascends till the valve is closed and suction stops automatically.

Note: Adopt the procedures mentioned in “Inspection &test on the overflow device” ,if the liquid level still ascends after the overflow device has been shut off.

- Emergency measures in the process of application:  
--Quickly loosen the negative pressure regulating knob to release the negative pressure if the suction tube is blocked by strong phlegm and mucus ,and start suction again after changing the suction tube.

--Adopt the above method to loosen the negative pressure regulating knob if it is not easy to take out the suction tube after completion of suction or the tube is adhered to human body tissue.

**Note 1:** Bend the tube in “V”form prior to starting suction ,insert the tube into the location of existing phlegm on the patient when the negative pressure reaches the desired range after start-up ,then ,recover the tube to its original status .This will lead to quicker suction effect.

**Note 2:** The medical personnel shall select the proper suction tube according to the clinical requirement.

**Note 3:** The aspirator shall be operated under the medical personnel's instructions strictly according to the scope of application and the operating sequence in the instruction manual .Please contact the supplier or manufacturer if there is any question.

### 2. Replace the air filter

When inhaling or stuffing with dust, the color of air filter will turn dark and may cause suction at the entrance of pipeline reduce or even disappear, negative pressure on medical suction table will rise to more than 0.04 MPa. it should be replaced a new one immediately.

Attention: 1. in use : the overflow device shut down, blockage can also cause the suction reduce or disappear and negative pressure rise. Please refer to “common fault analysis and ruled out”.

Attention: 2. the air filter should be replaced frequently, and concentrated destruction.

### 3.Changing the fuse tube

Fuse is inside the phlegm suction device. When replace it , first cut off power supply, unscrewed the screws at the bottom of device then take out the fuse anti-clockwise.

### 4.Maintenance

- Downtime before, it is recommended to have the suction tube suctioned small amount of clean water for cleaning up the inner wall.
- After use ,empty the reservoir bottle,clean up dirt on the holder and plug with soft brush or rag ,flush it with water and conduct sterilization.(including the overflow device ,the seal ring and various tubes .Unscrew the overflow device ,and separate the float from its support for completely cleaning up ,if necessary .)

Note:The rubber valve clack shall not be separated from the float.

- Use the physiological saline to clean out the residual strong phlegm and mucus in the tube after used .Replace the suction tube if not smooth .It is recommended to adopt one-time suction tube.

- Place the reservoir bottle ,cover and all tubes into the disinfectant compounded with the Kangweida disinfectant tables(0.5g per tablet)in 1:500 concentration for 1 hour .

Note: Keep the glass holder away from any sharp utensils to avoid drop in the process of cleaning and application.

- Wipe the case outer surface with lightly wet rag already soaked in the disinfectant ,and prevent any liquid seeping into the pump .Never wipe the places marked with letters and patterns.

- Place the machine in dry and clean places ,and periodically start running once a time (normally one time every 6 months)

**Note :** The device before use again , please install the overflow device ,conductor and other tubes as per the connecting mode before re-use.

## V、TROUBLE SHOOTING

1	Limit negative pressure <math><0.075\text{MPa}</math> or <math>0.0070\text{MPa}</math>	a. Holder mouth leakage; b. Leakage on connecting points; c. Regulating valve loose or released.	a. Remove dirt, tighten or change the holder cover, seal ring, and connector; b. Re-tighten each connection point; c. Turn tightly the regulating valve	a. Change the broken suction tube
2	Negative pressure >math>\geq 0.04\text{MPa}</math>, with distinct reduction or disappearing or suction force at tube outlet	a. Overflow device shut-off; b. Tube blockage; c. Air filter blockage	a. After shut-off, turn the regulating valve loose counterclockwise to release negative pressure in tube, then re-screw; b. Dredge, clean or replace the tube; c. Replace it with air filter produced by us.	a. Empty the holder timely; b. The end (in blue mark) of air filter is the air inlet
3	Normal power voltage, but the indicator doesn't illuminate	a. Fuse broken; b. Indicator damaged	a. Replace the fuse tube; b. Replace the indicator	a. Size: F1.6AL 250V $\Phi 5 \times 20$
4	Fuse tube broken	a. Voltage over high; b. Internal line in fault; c. Pump blocked and current increasing	a. Adjust voltage; b. Check the circuit line, and correct; c. Check the pump body and motor	By the specialized maintenance worker (Refer to Electric Systematic Diagram)

**Note:** The dismantling & repair on the pump body if fault shall be conducted by the specialized worker .Please contact the manufacturer if required.

(Please cut off power supply before check lines or open the case. )

## VI、OTHER PRECAUTIONS

### 1. Handling and storage environment conditions

- Ambient temperature : -40~55℃
- Relative humidity:  $\leq 95\%$
- Atmospheric pressure: 50kPa~106kPa

### 2. Electric systematic diagram and DC circuit diagram

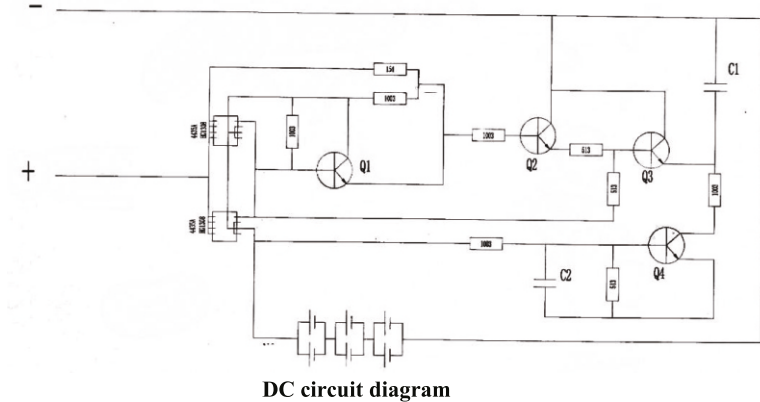
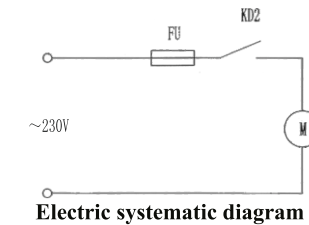

**Note:** Electric repair to be conducted by the specialized operator.

### 3. Attachments

- Suction soft pipe (length 1.3m) 1 pc
- Air filter 2 pcs
- Fuse tube 2 pcs
- Operational manual 1 copy
- Suction catheter 2 pcs

Be subject to any change on the circuit and outward appearance due to modification without notice.

## VII. FROM FOR ELECTROMAGNETISM COMPATIBILITY

Guidance and manufacture's declaration – electromagnetic emission		
The Portable Phlegm Suction Unit is intended for use in the electromagnetic environment specified below. The customer or the user of the Portable Phlegm Suction Unit should assure that it is used in such an environment.		
Emission test	Compliance level	Electromagnetic environment-guidance
RF emissions EN 55011	Group 1	The Portable Phlegm Suction Unit uses RF energy only for its internal function. Therefore, its RF emissions are very low and aren't likely to cause any interference in nearby electronic equipment.
RF emissions EN 55011	Class B	The Portable Phlegm Suction Unit is suitable for use in all establishments, including domestic establishments and those directly connected to the public low-voltage power supply network that supplies buildings used for domestic purposes.
Harmonic emission IEC 61000-3-2	Class A	
Voltage fluctuations/ flicker emissions IEC 61000-3-3	Complies	

Guidance and manufacture's declaration – electromagnetic immunity			
The Portable Phlegm Suction Unit is intended for use in the electromagnetic environment specified below. The customer or the user of the Portable Phlegm Suction Unit should assure that it is used in such an environment.			
Immunity test	EN 60601 test level	Compliance level	Electromagnetic environment-guidance
Electrostatic discharge (ESD) IEC 61000-4-2	± 6kV contact ± 8kV air	± 6kV contact ± 8kV air	Floor should be wood, concrete or ceramic tile. If floors are covered with synthetic material, the relative humidity should be at least 30%.
Electrical fast transient/burst IEC 61000-4-4	±2kV for power supply lines ± 1kV for input/output lines	±2kV for power supply lines	Main power quality should be that of a typical commercial or hospital environment.
Surge IEC 61000-4-5	±1kV differential mode ±2kV common mode	±1kV differential mode ±2kV common mode	Main power quality should be that of a typical commercial or hospital environment.
Voltage dips, short interruptions and voltage variations on power supply input	<5%U <sub>T</sub> (>95% dip in U <sub>T</sub> ) for 0.5 cycle	<5%U <sub>T</sub> (>95% dip in U <sub>T</sub> ) for 0.5 cycle	Main power quality should be that of a typical commercial or hospital environment.If the user of the Portable Phlegm Suction

lines IEC 61000-4-11	40%U <sub>T</sub> (60% dip in U <sub>T</sub> ) for 5 cycles  70%U <sub>T</sub> (30% dip in U <sub>T</sub> ) for 25 cycles  <5%U <sub>T</sub> (>95% dip in U <sub>T</sub> ) for 5 sec	40%U <sub>T</sub> (60% dip in U <sub>T</sub> ) for 5 cycles  70%U <sub>T</sub> (30% dip in U <sub>T</sub> ) for 25 cycles  <5%U <sub>T</sub> (>95% dip in U <sub>T</sub> ) for 5 sec	Unit requires continued operation during power mains interruptions ,it is recommended that the Porable Phlegm Suction Unit be powered from an uninterruptible power supply or a battery.
Power frequency (50/60 Hz) magnetic field IEC 61000-4-8	3A/m	3A/m	Power frequency magnetic fields should be at levels characteristic of a typical location in a typical commercial or hospital environment.

Note:U<sub>T</sub> is the a.c. main voltage prior to application of the test level.

### Guidance and manufacturer's declaration-electromagnetic immunity- for EQUIPMENT and SYSTEM that are not LIFE-SUPPORTING

Guidance and manufacture's declaration – electromagnetic immunity			
The Portable Phlegm Suction Unit is intended for use in the electromagnetic environment specified below. The customer or the user of the Portable Phlegm Suction Unit should assure that it is used in such an environment.			
Immunity test	Immunity test	Immunity test	Immunity test
Conducted RF EN 61000-4-6	3Vrms 150kHz to 80 MHz	3V	Protatable and mobile RF communications equipment should be used no closer to any part of the Portable Phlegm Suction Unit , including cables,than the recommended separation distance calculated from the equation applicable to the frequency of the transmitter. <b>Recommended separation distance</b> $d = \left[ \frac{5}{V_1} \right] \sqrt{P}$
Radiated RF EN 61000-4-3	3V/m 80 MHz to 2.5GHz	3V/m	$d = \left[ \frac{5}{E_1} \right] \sqrt{P} \quad 80 \text{ MHz to } 800\text{MHz}$ $d = \left[ \frac{7}{E_1} \right] \sqrt{P} \quad 800 \text{ MHz to } 2.5\text{GHz}$ where $p$ is the maximum output power rating of the transmitter in watts(W)according to the transmitter manufacture and $d$ is the recommended

			separation distance in metres(m). <sup>b</sup> Field strengths from fixed RF transmitters ,as determined by an electromagnetic site survey, <sup>a</sup> should be less than the compliance level in each frequency range. <sup>b</sup> Interference may occur in the vicinity of equipment mark with the following symbol: 
--	--	--	--

**NOTE 1** At 80 MHz to 800MHz,the higher frequency range applies.  
**NOTE 2** These guidelines may not apply in all situations. Electromagnetic is affected by absorption and reflection from structures,objects and people.

<sup>a</sup> Field strength from fixed transmitters,such as base station for radio(cellular/cordless)telephones and land mobile radios,amateur radio,AM and FM radio broadcast and TV broadcast cannot be predicted theoretically with accuracy.To assess the electromagnetic environment due to fixed RF transmitters,an electromagnetic site survey should be considered.If the measured field strength in the location in which the Portable Phlegm Suction Unit is used exceeds the applicable RF compliance level above,the Portable Phlegm Suction Unit should be observed to verify normal operation.If abnormal performance is observed,additional measures may be necessary,such as reorienting or relocating the Portable Phlegm Suction Unit.

<sup>b</sup> Over the frequency range 150kHz to 80MHz,field strengths should be less than 3V/m.

**Recommended separation distances between portable and mobile RF communications equipment and the Portable Phlegm Suction Unit**

The Portable Phlegm Suction Unit is intended for use in an electromagnetic environment in which radiated RF disturbances are controlled.The customer or the user of the Portable Phlegm Suction Unit can help prevent electromagnetic interference by maintaining a minimum distance between portable and mobile RF communications equipment(transmitters) and the Portable Phlegm Suction Unit as recommended below,according to the maximum output power of the communications equipment.

Rated maximum Output of transmitter W	Separation distance according to frequency of transmitter		
	150kHz to 80MHz $d = \left\{ \frac{5}{V_1} \right\} \sqrt{P}$	80MHz to 800MHz $d = \left\{ \frac{5}{E_1} \right\} \sqrt{P}$	800MHz to 2.5GHz $d = \left\{ \frac{7}{E_1} \right\} \sqrt{P}$
0.01	0.12	0.12	0.23
0.1	0.38	0.38	0.73
1	1.2	1.2	2.3
10	3.8	3.8	7.3
100	12	12	23

For transmitters rate at a maximum output power not listed above the recommended separation distance *d* in metres(m) can be estimated using the equation applicable to the transmitter,where *P* is the maximum output power rating of the transmitter in watts(W)according to the transmitter manufacture.

**NOTE 1** At 80MHz and 800MHz,the separation distance for the higher frequency range applies.  
**NOTE 2** These guidelines may not apply in all situations.Electromagnetic propagation is affected by absorption and reflection from structures,objects and people.

**VIII、 AFTER-SALE SERVICE**

- Under the condition of normal use and storage, a portable sputum suction device since the date of sale within one year (business inventories) can't normal use within a week, the company for free repair or replacement; Half a year can't use, the user can according to the invoice and warranty card to the company's after-sales service for free repair, office, or a distributor; Cannot be used after half a year, the company to provide spare parts for maintenance, reasonable charge.
- Of the following does not belong to the warranty scope:
  1. The machine damage or deformation due to collision
  2. The machine into water or in the rain
  3. User water, blood, phlegm, or glue inside the liquid suction pump can't work normally.
- Necessary information on the circuit diagram and for check is available upon request .Please contact the manufacturer if there is any problem related to the circuit check.

# WARRANTY

This appliance is warranted for a period of One Year from the date of purchase as shown by the dealer's stamp and signature and by the purchaser's receipt.

**WARRANTY CARD**

Model No..... Lot No.....

Invoice No..... Date of Purchase.....

Purchased by :..... Contact No. :.....

Address.....

Dealer Name.....

Dealer Sign & Stamp